

# 1000 Trials: An Empirically Validated End Effector that Robustly Grasps Objects from the Floor

Zhe Xu  
University of Washington  
Seattle, WA 98195  
e-mail: zhuxu@u.washington.edu

Travis Deyle  
Georgia Institute of Technology  
Atlanta, Georgia 30332  
e-mail: tdeyle@gatech.edu

Charles C. Kemp  
Georgia Institute of Technology  
Atlanta, Georgia 30332  
e-mail: charlie.kemp@bme.gatech.edu

**Abstract**—Unstructured, human environments present great challenges and opportunities for robotic manipulation and grasping. Robots that reliably grasp household objects with unknown or uncertain properties would be especially useful, since these robots could better generalize their capabilities across the wide variety of objects found within domestic environments.

Within this paper, we address the problem of picking up an object sitting on a plane in isolation, as can occur when someone drops an object on the floor - a common problem for motor-impaired individuals. We assume that the robot has the ability to coarsely position itself in front of the object, but otherwise grasps the object with an open-loop strategy that does not vary from object to object.

We present a novel end effector that is capable of robustly picking up a diverse array of everyday handheld objects given these conditions. This straight-forward, inexpensive, nonprehensile end effector combines a compliant finger with a thin planar component with a leading wedge that slides underneath the object. We empirically validated the efficacy of this design through a set of 1096 trials over which we systematically varied the object location, object type, object configuration, and floor characteristics. Our implementation, which we mounted on a iRobot Create, had a success rate of 94.71% on 680 trials, which used 4 floor types with 34 objects of particular relevance to assistive applications in 5 different poses each ( $4 \times 34 \times 5 = 680$ ). The robot also had strong performance with objects that would be difficult to grasp using a traditional end effector, such as a dollar bill, a pill, a cloth, a credit card, a coin, keys, and a watch. Prior to this test, we performed 416 trials in order to assess the performance of the end effector with respect to variations in object position.

## I. INTRODUCTION

Autonomous mobile manipulation in the home has the potential to beneficially impact the lives of millions of people, but significant challenges must first be overcome [1]. Homes vary in their internal structure and contain a wide variety of objects, including unique handmade items and mass produced products subject to wear and tear. Ideally, we would like robots to be able to robustly grasp these objects in unmodified homes. Within this paper we look at a constrained version of this general grasping problem. *How can a mobile robot reliably grasp an object that is sitting on the floor in front of it?*

Many researchers have pursued a model-based approach to grasping, wherein a robot creates a model of the object or registers a pre-existing model to the object, searches for viable grasps in simulation, and then attempts to use these grasps on the object in the real world. A compelling alternative to this

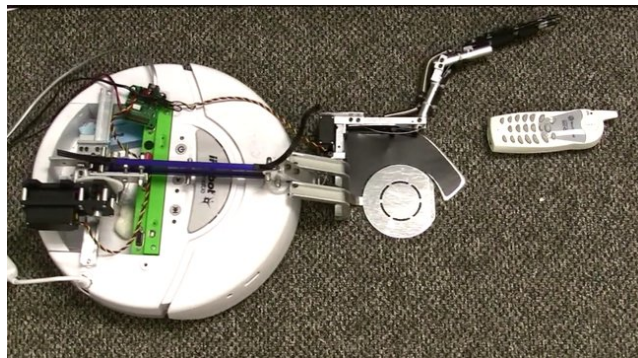

Fig. 1. The robot described in this research prior to attempting to grasp a cordless phone on the carpeted floor.

sense-plan-act style of manipulation is to develop algorithms and mechanisms that do not require a model of the object, sophisticated sensory inference, or grasp planning. Within this paper we present an end effector whose mechanical design enables it to robustly grasp a wide variety of objects from the floor with a sensorless, open-loop grasp controller. The robot can successfully grasp these objects without knowing their identity or orientation, and only uses coarse information about their planar position, overall size, and overall shape. Furthermore, the robot does not need to know the characteristics of the floor on which it is operating.

In order to validate the efficacy of our approach, we tested the grasping performance of a mobile robot using the end effector (see Figure 1) in a total of 1096 trials over which we systematically varied the object's type, the floor type, the object's configuration, and the object's position. The everyday objects we used in our tests incorporate a variety of materials and exhibit diverse mechanical properties and complicated interactions with sensors that go beyond the state of the art in physical simulation (e.g., cloth, paper, cardboard, plastics, carpet, friction, contact, and transparency) [2], [3], [4], [5], [6]. Given the challenges inherent in adequately simulating the perceptual and physical interactions involved in grasping these everyday objects and the ultimate goal of real-world operation, we believe that performing tests in the real world is essential [7].

The following sections of this paper cover the motivations

for this research, inspirations for the design, related work, the implementation of the end effector and the robot, experimental evaluation, and conclusions.

## II. MOTIVATION

Assistive robots serve as the main motivator for this research. People with motor impairments have consistently placed a high priority on the ability of a robot to retrieve dropped objects from the floor [8]. Motor impairments can both increase the chances that an individual will drop an object and make recovery of the object difficult or impossible. For this research, we assume that a dropped object will tend to be isolated on the floor and that the robot will be able to position itself so that it is facing the object with an unobstructed path between it and the object.

In addition to its direct relevance to assistive robotics, a robot that reliably grasps objects from the floor could be useful for house cleaning and organization. We also believe the end effector we present has wider implications for robots that autonomously grasp objects, since analogous methods of grasping are used by humans.

## III. DESIGN INSPIRATION

We designed and implemented a straight forward and inexpensive end effector, shown in Figure 1, and affixed it to a simple 1-DoF arm attached to an iRobot Create. The design, detailed later, pulls elements from several different inspirations. First, it implicitly takes advantage of the prevalence of flat surfaces that are orthogonal to gravity within indoor human environments. As we have previously demonstrated, robots can take advantage of this structure when manipulating objects [9]. In the current paper, the end effector has the goal of sliding an object from a flat and relatively smooth surface in the world onto a smooth, flat surface that is integral to the end effector. If we assume that the dynamics involved in this operation are insignificant and that the object is statically stable on the initial surface, we can expect for the object to be in a statically stable configuration once it has been transferred to the end effector’s flat surface. Second, as shown in Figure 2, humans often use similar strategies to grasp everyday objects in domestic environments using their bare hands or tools. These strategies tend to make use of a wedge that can be pushed under the object, a surface onto which the object can be slid, and a member (or friction) that applies force to the opposite side of the object in order to slide it over the wedge and onto the surface. Our end effector design emulates these same components. With their bare hands, people often use their finger nail as a wedge with which to get under an object, use their fingers or palm as a surface onto which to push an object, and apply force to the opposite side of an object either actively or passively using the thumb, palm, or fingers. Moreover, common household tools, such as a brush and dustpan or a kitchen turner, serve as specialized end effectors for humans that take advantage of similar mechanics as well as the planar structure of indoor environments. Third, we use a compliant

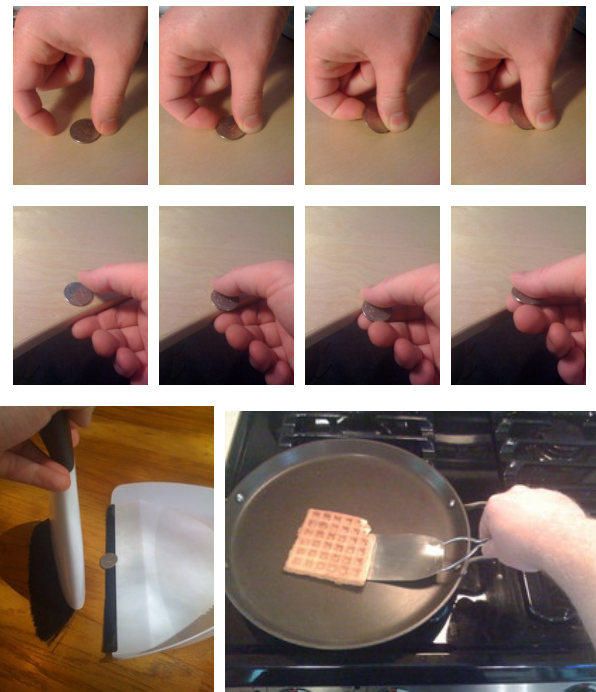

Fig. 2. Four examples of related grasping methods during everyday household manipulation. *Top Row*: Picking up a coin from a flat surface with thumb and forefinger fingernail. *Middle Row*: Sliding a coin off a table edge and onto the forefinger. *Bottom Left*: Use of brush and dustpan. *Bottom Right*: Use of a kitchen turner.

finger inspired by the work of Dollar and Howe [10], [11] to sweep the object onto the flat surface and hold it there.

## IV. RELATED WORK

There is a large corpus of grasping work that depends on explicit models, either estimated or known *a priori* [1]. These methods have been successful with small sets of objects, but their ability to scale to the diverse array of objects found within indoor human environments has yet to be demonstrated [12], [13], [14], [15]. Downloading models over the web and creating new models with human interaction may help this approach scale, but the robots will need to reliably select and register models from a potentially vast database given real-world sensor data. More troubling is the inevitable existence of unmodeled, difficult to model, and one-of-a-kind objects that are likely to be found in domestic settings. This suggests that robots will sometimes need to operate with both incomplete *a priori* knowledge and imperfect sensing [1]. Fortunately, recent research, including this paper, indicates that explicit object models may be unnecessary for basic pick and place tasks in indoor environments. Consequently, we expect for these model-free methods to be effective, valuable, and complementary to model-based approaches.

Two broad types of approaches have demonstrated success in performing model-free grasping under some circumstances: (1) Create or learn mappings from sparse, task-relevant sensing to specialized controllers [9], [16], [17], [18], [19]. (2) Use robust mechanical mechanisms, such as a compliant gripper

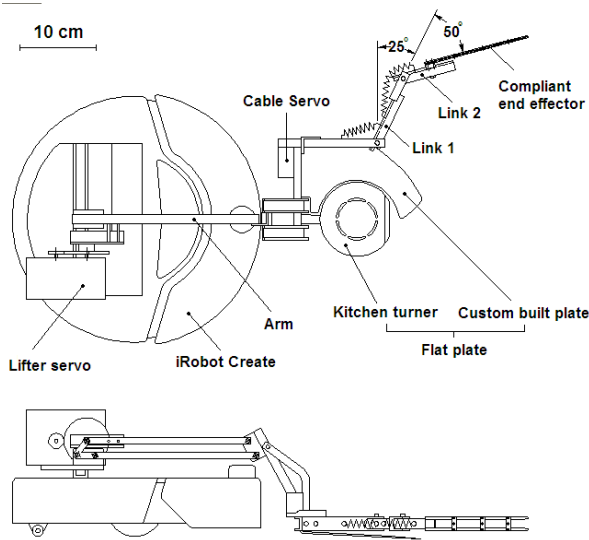

Fig. 3. Schematic drawing of the end effector and robot.

[10], [11]. Our end effector falls very much in the tradition of approach 2, since it uses open-loop control and mechanical design to achieve robust model-free grasping. Given its open-loop approach to control, it also relates to work on sensorless manipulation [20].

In combination, these papers demonstrate the utility of a model-free approach to grasping. For all of them, a coarse estimate of the position of the object is the only requirement for an (often successful) grasp attempt, since the generalized model or the mechanical mechanism implicitly accounts for position error, pose, and other forms of variation in the object and environment. In each case, the authors' design is experimentally verified using anywhere from 4 to 12 objects and up to 150 grasp attempts. However, there was no consensus about which objects to use or how they should be configured.

All of the above approaches have relied on prehensile grasping, usually with a hand or fingers closing around the object. Our end effector uses a nonprehensile approach to perform model-free grasping, unlike previous work [21].

## V. SYSTEM OVERVIEW

This section describes the mechanical design and the grasping algorithm.

### A. Mechanical Design

The robot is composed of four major components, as illustrated in Figure 3: the iRobot Create base, the arm, a flat plate with a leading wedge, and a 2-link compliant finger.

Attached to the cargo bay of the iRobot Create base is a 1-DoF, 0.194 meter parallel linkage adapted from an off-the-shelf folding desk lamp. We call this component the arm, as it is responsible for raising (up to 0.14m) or lowering (down to 0.0m) the end effector before and after an object has been swept onto the flat plate. The arm is actuated by a servo attached to the iRobot Create base. To accurately size the servo, we calculated the required torque, which is comprised

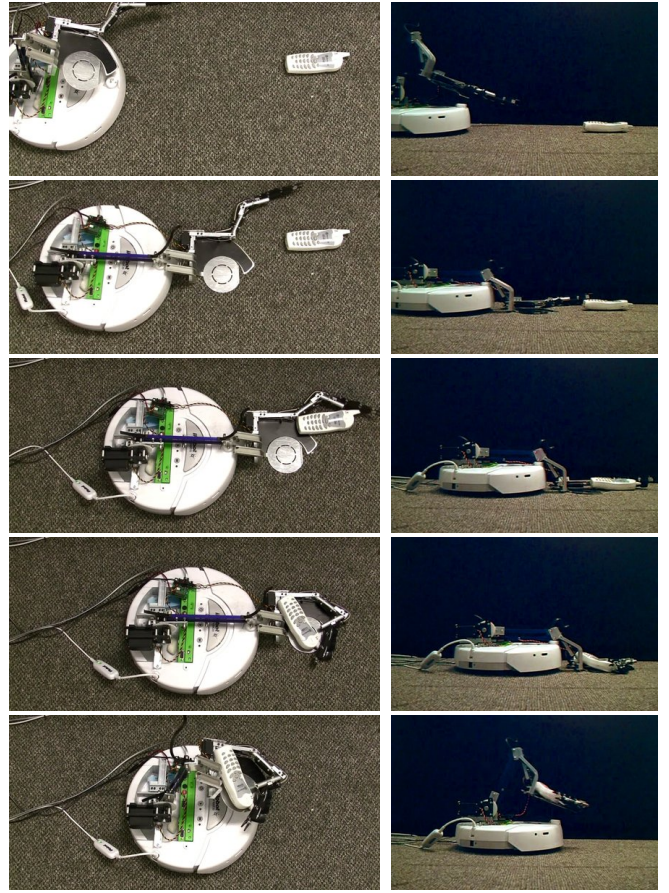

Fig. 4. This sequence of images taken from above (left) and from the side (right) while the robot was grasping a cordless telephone illustrate the control algorithm.

of two components: a 1 kg (10 N) object load on the plate center (a lever of length 0.322m) and the load imposed by the arm mechanism and plate mass (2.8 N with a center of mass / lever length of 0.194m).

$$\tau_{obj} = F_{obj} \cdot r_{obj} = 10.0N \cdot 0.322m \approx 32.2kg \cdot cm \quad (1)$$

$$\tau_{arm} = F_{arm} \cdot r_{arm} = 2.8N \cdot 0.194m \approx 5.4kg \cdot cm \quad (2)$$

$$\tau_{total} = \tau_{obj} + \tau_{arm} = 32.2 + 5.4 \approx 37.6kg \cdot cm \quad (3)$$

To allow sufficient margin of error, we chose the SPG785 Pan (HS-785HB servo with 1:3 gear ratio) with a maximum torque of  $39.5 kg \cdot cm$ . At the opposite end of the arm sits the 2-joint finger mounted on the left side of the flat plate. The arm tilts the flat plate slightly down towards the floor to provide good contact during grasping when it must slide underneath the object. The plate consists of a kitchen turner and a custom machined piece of metal to extend the plate.

A 2-joint compliant manipulator acts as a brush to sweep objects from a stable configuration on the floor to a stable configuration on the flat plate. To improve grasping, particularly for small, flat objects, each link attempts to minimize clearance with the floor via soft foam attached beneath the link's rigid

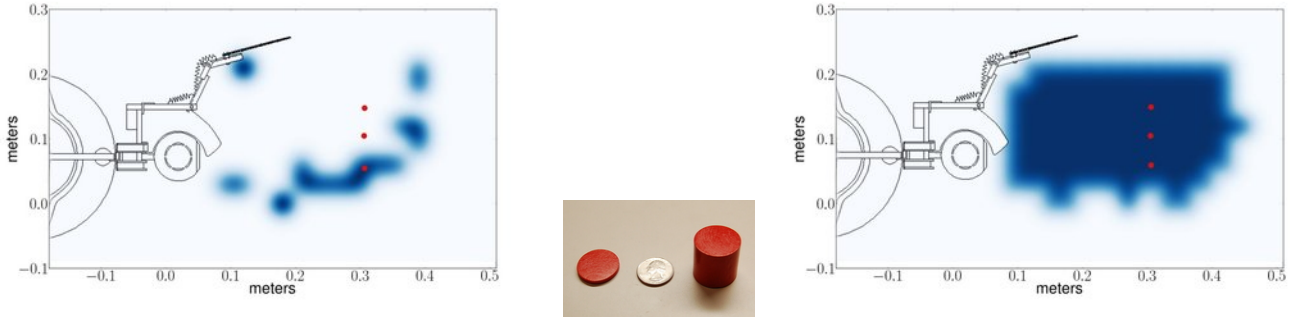

Fig. 5. The left and right images show the results of grasping tests with the test objects (red wooden cylinders) in the middle image. The dark areas in the left image show areas where the robot successfully grasped the short red test object on the left side of the middle image. The dark areas in the right image show where the robot successfully grasped the tall red test object on the right side of the middle image. The quarter in the middle image is included to illustrate the size of the test objects. The three small red dots on the left and right images show the locations that were used when testing the robot with (from top to bottom) large objects, medium sized thin objects, and small objects.

aluminum tubing. The sections between links are revolute joints, designed to be compliant in the plane of finger motion and stiff out of plane. For Joint-1 and Joint-2 (see Figure 3), the rest angle configuration is  $25^\circ$  and  $50^\circ$  respectively. These angles were chosen based on the work of Dollar and Howe [10], [11].

The compliance in the manipulator is achieved through retention springs connected between the links, forming an underactuated system. The finger is closed by pulling on a single  $0.914\text{ mm}$  diameter steel cable using a Hitec HS-5955TG servo with a lever arm ( $r=0.019\text{m}$ ). The cable is anchored on Link-2 and runs through the bodies of Link-1 and the base link to the servo. Early tests indicated that a force of 35 Newtons would be required to fold the compliant finger with no object present. This amounts to a required cable servo torque given by:

$$\tau = F \cdot r = 35\text{N} \cdot 0.019\text{m} = 0.665\text{N} \cdot \text{m} \approx 6.65\text{kg} \cdot \text{cm} \quad (4)$$

The Hitec HS-5955TG supplies up to  $24.0\text{ kg} \cdot \text{cm}$  – a magnitude that proved to be sufficient to grasp all 34 objects on all four surfaces during our tests.

### B. Grasping Algorithm

Snapshots of the basic grasping process are shown in Figure 4. These motions are initiated by pressing a single button, and they are carried out by the robot without significant sensor feedback or variation in the control. The only feedback is used internally by the servo motors and the mobile base to ensure that the predefined trajectories are followed. We assume that the robot has already navigated such that it can move in a straight line towards the location of the object. As the robot approaches the object, the arm gradually lowers the end effector to the floor such that the leading edge (wedge) of the flat plate makes good contact with the floor. The robot continues to move forward for a fixed distance. During this forward motion, the edge of the plate comes into contact with the object. After a predefined distance, the finger closes.

During a successful grasp, the compliant finger is able to gradually pull the object onto the plate as the iRobot Create base simultaneously continues forward, pushing the plate under the object. The cable-driven, compliant finger is actuated to its furthest position (closed), and then the arm raises the end effector. When successful the object is sitting on the flat plate and is raised up with the end effector. In this version of the robot the flat plate is tilted, so as to make firm contact with the floor when lowered. Unfortunately, this sometimes results in the object toppling over when the end effector is raised. We have worked to correct this problem in the second version of the robot that we discuss later by adding an additional degree-of-freedom that tilts the end effector and ensures that it remains flat as it is raised off of the floor.

Further details of this control algorithm follow. The robot starts by moving forward at  $6\text{ cm/sec}$  for 5 seconds. After the first second of forward motion the robot begins to lower its arm at a rate of approximately  $1.05\text{ rad/sec}$ , which results in the arm being fully lowered after around 1.5 more seconds (lowered  $90^\circ$ ). After the first 5 seconds of forward motion, the robot slows down to  $4\text{ cm/sec}$  to grasp the object and continues to move forward for 3.8 seconds. At the same time that it slows down it starts to close its compliant finger. Once the robot has fully stopped, it slowly raises its arm, ideally with the grasped object on the flat plate.

### C. Mechanical Considerations

One significant choice in the design of the end effector is the distance of the compliant finger off of the floor. Several factors argue for a small distance. First, the net torque applied to the object by the compliant finger and the front wedge of the flat plate will be reduced as the finger's distance from the floor is decreased. A lower net torque can help maintain the pose of the object while it is transferred to the flat plate. Second, if the distance between the finger and the floor were large, the net torque on the object would tend to press the front of the object's base down on the front wedge of the flat plate. This downward force would resist the desired movement of the



Fig. 6. Four common floor types used in the experiments: Wood floor, short pile carpet, tile floor, and medium pile carpet

plate beneath the object and increase the chance of toppling. For this reason, a good location for the finger contact point is below the center of mass of the object. Third, a low position simplifies sweeping the floor for objects with a low profile.

## VI. EXPERIMENTAL EVALUATION

In total, we performed 1096 grasp attempts with 34 different objects in various configurations on 4 different surfaces. We separated the experiments into two different groups: testing position dependencies and testing across objects, object configurations, and surfaces. We tested position dependencies first to find consistent locations at which to place the objects.

### A. Testing Performance Based on Object Position

Our initial desire was to determine how detrimental position errors were to successful grasps. Early experiments indicated that this was largely dependent on the object's size. Thus, to examine position dependencies, we chose two representative objects: one large wooden cylinder (height=0.031m, diameter=0.030m) and one small wooden cylinder (height=0.003m, diameter=0.030). We tested grasping with the large and small objects a total of 312 and 104 times respectively on a smooth wooden floor for a total of 416 grasp attempts. For both objects we used a 17x12 grid with 0.030m resolution, but for our first tests with the large object, we performed 3 tests at each location to verify the consistency of the robot's performance. Due to the very high consistency of the results, we chose to only perform a single test at each location with the small object.

The results of these trials are illustrated in Figure 5. The robot successfully grasped the large object over a wide range of positions. Grasping the smaller object was still robust to position variation relative to the object's size, but suffered compared to the larger object. Anecdotally, we attribute the inability to grasp the small object to a number of factors. First, the portion of the flat plate that was custom built has a duller front wedge compared to the pancake turner, which deterred the small object from being swept onto the flat plate. Second, when the small object was swept onto the flat plate, it occasionally fell off while being lifted through a gap between the compliant finger and the flat plate. We have tried to address

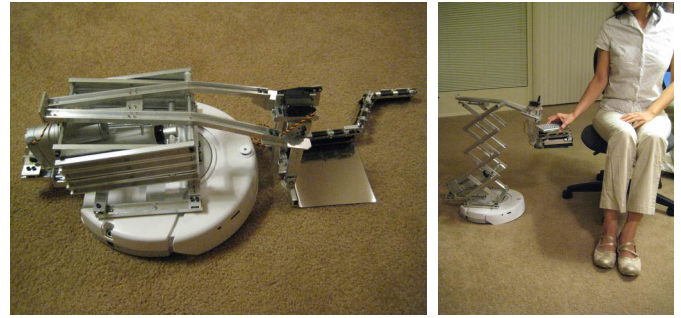

Fig. 7. These images show the new version of the robot we are developing. We have completed the mechanical design and assembly and are working on the control system. We posed the robot for these pictures. *Left*: Robot in configuration to grasp object from the floor. *Right*: The robot is designed to lift the object so it can comfortably deliver it to a person and potentially place it on a table.

both of these failure modes in a subsequent prototype by redesigning the flat plate to have a more consistent front edge, and by providing a firmer, more continuous sweeping mechanism beneath the links of the compliant finger.

Based on these tests and additional informal testing with various objects, we chose three locations at which to place the objects during subsequent tests. We chose these locations because we expected them to maximize the grasping performance. As denoted by the dots in Figure 5 and superscripts in the results tables (Tables I and II), we used the top location for large objects, the middle location for medium-sized flat objects, and the bottom location for small flat objects. As shown in the figure, the grasping performance was much more sensitive to the position of small objects than to the position of large objects. We believe that this variation will be significantly reduced with the new version of the robot (see Figure 7), since the variation appears to be a direct consequence of the piecemeal construction of this first prototype.

### B. Testing Over Objects, Object Configuration, and Surfaces

Previously, we remarked that there is currently no consensus on how robotic grasping should be evaluated. We chose to systematically vary important characteristics over the trials, including the object used, the object's configuration, and the type of floor upon which the object is sitting. We varied the type of object in order to test the robot's ability to pick up a diverse array of objects without object recognition. We varied the configuration of the objects, since we assume that the robot does not know the orientation of objects nor the configuration of articulated objects. We varied the floor, because homes have different types of flooring and because the end effector's performance critically depends on the ability of the flat plate to move under the object. As shown in Figure 4, this happens due to a combination of the plate pushing between the floor and the bottom of the object, and the object being pushed across the floor onto the flat plate.

This still leaves the question as to what objects we should use in our tests. Based on our research with physically impaired people who have amyotrophic lateral sclerosis (ALS),

we have identified objects that these potential users would like to have a robot retrieve for them [2]. We used the preliminary version of this work to come up with 34 objects representative of the objects that a motor-impaired person might drop on the floor and want a robot to recover. In addition to the objects, we needed to determine the orientations, positions, and flooring to use in our tests. With so many variables, combinatorial explosion makes it impractical to test everything. Instead, we opted for a disciplined sampling strategy. We fabricated 2 small sections of flooring common to household environments (wood and tile), bought a small carpet sample (medium pile), and used the carpeted floor in our lab (short pile), as shown in Figure 6. We did not conduct tests with deep-pile carpet, because iRobot recommends against the use of the iRobot Create on deep pile. In our experience, deep-pile carpet interferes with the robot’s motion. A grasp attempt was made for each object at the previously determined location, in five configurations, and on each of these 4 floors – resulting in  $34 \cdot 5 \cdot 4 = 680$  grasp attempts. We attempted to pick 5 representative object configurations that included variations in the object’s orientation and any other remaining degrees of freedom. We show pictures of these configurations for each object in the results. The algorithm shown in Figure 4 was performed in each attempt, resulting in the data displayed in Table I, and continuing in Table II.

Over these 680 trials, the end effector achieved an overall success rate of 94.71%.

## VII. CONCLUSION

We have described the design and evaluation of a novel, inexpensive end effector to grasp everyday household objects from the floor. The design makes use of 3 main components: a flat surface, a wedge, and a member to apply force. The end effector performs a nonprehensile grasp of an object by sliding the object onto the flat surface. For our implementation, we used a compliant finger to push the object onto a thin, smooth aluminum plate with a sharp, leading wedge. In our extensive experiments, this straightforward design performed well over a large set of objects, object configurations, and floors, without the need for complex models, sensing, or control. We expect for similar designs with small modifications to perform even better, and we have already designed and constructed a second version of the robot and end effector, see Figure 7. We also believe related, nonprehensile grasp strategies using more general end effectors hold promise for robots operating in human environments.

## VIII. ACKNOWLEDGEMENT

We thank the patients from the Emory ALS Center for their great help on the object list. We also thank Hai Nguyen for writing the initial scripts to control the robot. This work also benefited from discussions with Cressel D. Anderson and Advait Jain.

## REFERENCES

- [1] C. Kemp, A. Edsinger, and E. Torres-Jara, “Challenges for robot manipulation in human environments [grand challenges of robotics],” *Robotics and Automation Magazine, IEEE*, vol. 14, no. 1, pp. 20–29, March 2007.
- [2] Y. S. Choi, T. Deyle, and C. C. Kemp, “A List of Household Objects for Robotic Retrieval Prioritized by People with ALS (Version 092008),” *E-Print: arXiv/0902.2186*, 2009.
- [3] J. Brown, S. Sorkin, C. Bruyns, J. Latombe, K. Montgomery, and M. Stephanides, “Real-time simulation of deformable objects: Tools and application,” *Computer Animation*, vol. 2, 2001.
- [4] R. Bridson, R. Fedkiw, and J. Anderson, “Robust treatment of collisions, contact and friction for cloth animation,” *International Conference on Computer Graphics and Interactive Techniques*, 2005.
- [5] D. Baraff and A. Witkin, “Large steps in cloth simulation,” *Proceedings of the 25th annual conference on Computer graphics and interactive techniques*, pp. 43–54, 1998.
- [6] A. Bicchi and V. Kumar, “Robotic grasping and contact: a review,” *Robotics and Automation, 2000. Proceedings. ICRA’00. IEEE International Conference on*, vol. 1, 2000.
- [7] R. Brooks, “Elephants Don’t Play Chess,” *Designing Autonomous Agents: Theory and Practice from Biology to Engineering and Back*, pp. 3–15, 1991.
- [8] C. Stanger, C. Anglin, W. Harwin, and D. Romilly, “Devices for assisting manipulation: a summary of user task priorities,” *Rehabilitation Engineering, IEEE Transactions on*, vol. 2, no. 4, pp. 256–265, Dec 1994.
- [9] H. Nguyen, C. Anderson, A. Trevor, A. Jain, Z. Xu, and C. C. Kemp, “El-e: An assistive robot that fetches objects from flat surfaces,” *Proceedings of “Robotic Helpers: User Interaction, Interfaces and Companions in Assistive and Therapy Robotics” an HRI Workshop*, March 12, 2008.
- [10] A. Dollar and R. Howe, “Simple, robust autonomous grasping in unstructured environments,” *Robotics and Automation, 2007 IEEE International Conference on*, pp. 4693–4700, April 2007.
- [11] —, “Towards grasping in unstructured environments: optimization of grasper compliance and configuration,” *Intelligent Robots and Systems, 2003. (IROS 2003). Proceedings. 2003 IEEE/RSJ International Conference on*, vol. 4, pp. 3410–3416 vol.3, Oct. 2003.
- [12] F. Rothling, R. Haschke, J. J. Steil, and H. Ritter, “Platform portable anthropomorphic grasping with the bielefeld 20-dof shadow and 9-dof tum hand,” in *Intelligent Robots and Systems, 2007. IROS 2007. IEEE/RSJ International Conference on*, 2007, pp. 2951–2956. [Online]. Available: <http://dx.doi.org/10.1109/IROS.2007.4398963>
- [13] S. Srinivasa, D. Ferguson, M. Weghe, R. Diankov, D. Berenson, C. Helfrich, and H. Strasdat, “The Robotic Busboy: Steps Towards Developing a Mobile Robotic Home Assistant,” in *International Conference on Intelligent Autonomous Systems*, 2008.
- [14] T. Asfour, P. Azad, N. Vahrenkamp, K. Regenstein, A. Bierbaum, K. Welke, J. Schröder, and R. Dillmann, “Toward humanoid manipulation in human-centred environments,” *Robotics and Autonomous Systems*, 2007.
- [15] D. Kragic, M. Bjrkmán, H. I. Christensen, and J.-O. Eklundh, “Vision for robotic object manipulation in domestic settings,” *Robotics and Autonomous Systems*, vol. 52, no. 1, pp. 85–100, 2005.
- [16] L. Natale and E. Torres-Jara, “A sensitive approach to grasping,” September 2006.
- [17] A. Saxena, J. Driemeyer, and A. Y. Ng, “Robotic Grasping of Novel Objects using Vision,” *The International Journal of Robotics Research*, vol. 27, no. 2, pp. 157–173, 2008.
- [18] S. Hirai, T. Tsuboi, and T. Wada, “Robust grasping manipulation of deformable objects,” *Assembly and Task Planning, 2001. Proceedings of the IEEE International Symposium on*, pp. 411–416, 2001.
- [19] Z. Jiang and M. Kohno, “Robotic manipulation of flexible objects based on vibration control using force sensors,” *Systems, Man and Cybernetics, 2002 IEEE International Conference on*, vol. 4, 2002.
- [20] M. Erdmann and M. Mason, “An exploration of sensorless manipulation,” *IEEE Journal of Robotics and Automation*, vol. 4, no. 4, pp. 369–379, August 1988.
- [21] M. Erdmann, “An exploration of nonprehensile two-palm manipulation: Planning and execution,” *The International Journal of Robotics Research*, no. 5, pp. 485–503, 1998.

TABLE I  
 “DUSTPAN” ROBOT OBJECT EVALUATION – VARYING OBJECT, ORIENTATION, AND SURFACE





























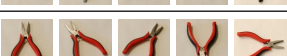



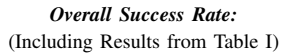
	Object	Orientations	Surfaces			
			Short Pile Carpet	Medium Pile Carpet	Tile Flooring	Wood Flooring
1.	Medicine Bottle		5/5 = 100%	5/5 = 100%	5/5 = 100%	5/5 = 100%
2.	Medicine Box (Claritin)		5/5 = 100%	5/5 = 100%	5/5 = 100%	5/5 = 100%
3.	Single Pill <sup>o</sup>		5/5 = 100%	5/5 = 100%	5/5 = 100%	5/5 = 100%
4.	Wallet		5/5 = 100%	5/5 = 100%	5/5 = 100%	5/5 = 100%
5.	Soap		5/5 = 100%	5/5 = 100%	5/5 = 100%	5/5 = 100%
6.	TV Remote		5/5 = 100%	5/5 = 100%	5/5 = 100%	5/5 = 100%
7.	Cordless Telephone		5/5 = 100%	5/5 = 100%	5/5 = 100%	5/5 = 100%
8.	Cellphone		5/5 = 100%	5/5 = 100%	5/5 = 100%	5/5 = 100%
9.	Glasses		5/5 = 100%	5/5 = 100%	5/5 = 100%	5/5 = 100%
10.	Keys <sup>o</sup>		5/5 = 100%	5/5 = 100%	4/5 = 80%	5/5 = 100%
11.	Credit Card*		5/5 = 100%	5/5 = 100%	3/5 = 60%	2/5 = 40%
12.	Microfiber Cloth*		5/5 = 100%	5/5 = 100%	5/5 = 100%	5/5 = 100%
13.	\$20 USD* Dollar Bill		5/5 = 100%	5/5 = 100%	5/5 = 100%	5/5 = 100%
14.	Quarter (\$0.25 USD) <sup>o</sup>		5/5 = 100%	5/5 = 100%	5/5 = 100%	4/5 = 80%

TABLE II  
 “DUSTPAN” ROBOT OBJECT EVALUATION – VARYING OBJECT, ORIENTATION, AND SURFACE (CONTINUED FROM TABLE I)

	Object	Orientations	Surfaces				
			Short Pile Carpet	Medium Pile Carpet	Tile Flooring	Wood Flooring	
15.	Single Key <sup>o</sup>		5/5 = 100%	5/5 = 100%	3/5 = 60%	4/5 = 80%	
16.	Plate		5/5 = 100%	5/5 = 100%	5/5 = 100%	5/5 = 100%	
17.	Plastic Fork*		4/5 = 80%	5/5 = 100%	4/5 = 80%	3/5 = 60%	
18.	Plastic Spoon*		5/5 = 100%	5/5 = 100%	5/5 = 100%	5/5 = 100%	
19.	Knife*		4/5 = 80%	5/5 = 100%	5/5 = 100%	5/5 = 100%	
20.	Cup		5/5 = 100%	5/5 = 100%	5/5 = 100%	5/5 = 100%	
21.	Toothpaste Bottle		4/5 = 80%	4/5 = 80%	4/5 = 80%	4/5 = 80%	
22.	Toothpaste Tube		5/5 = 100%	5/5 = 100%	4/5 = 80%	4/5 = 80%	
23.	Book		5/5 = 100%	5/5 = 100%	5/5 = 80%	5/5 = 80%	
24.	Lighter		5/5 = 100%	5/5 = 100%	5/5 = 100%	5/5 = 100%	
25.	Wristwatch		4/5 = 80%	5/5 = 100%	5/5 = 100%	5/5 = 100%	
26.	Hair Brush		3/5 = 60%	4/5 = 80%	5/5 = 100%	5/5 = 100%	
27.	Large Plastic Container		5/5 = 100%	5/5 = 100%	5/5 = 100%	3/5 = 60%	
28.	Nalgene Bottle		2/5 = 40%	4/5 = 80%	5/5 = 100%	2/5 = 40%	
29.	Sharpie Marker		5/5 = 100%	5/5 = 100%	5/5 = 100%	5/5 = 100%	
30.	Wire Cutter		5/5 = 100%	5/5 = 100%	5/5 = 100%	5/5 = 100%	
31.	Flashlight		5/5 = 100%	5/5 = 100%	5/5 = 100%	5/5 = 100%	
32.	Odwalla Juice Bottle		5/5 = 100%	5/5 = 100%	5/5 = 100%	5/5 = 100%	
33.	Baby Bottle		5/5 = 100%	5/5 = 100%	5/5 = 100%	5/5 = 100%	
34.	Stuffed Toy		5/5 = 100%	5/5 = 100%	5/5 = 100%	5/5 = 100%	
<sup>o</sup> Indicates <i>Small</i> Object * Indicates <i>Medium</i> Object			<b>Overall Success Rate:</b> (Including Results from Table I)	<b>161 / 170</b> (94.71%)	<b>167 / 170</b> (98.24%)	<b>161 / 170</b> (94.71%)	<b>155 / 170</b> (91.18%)